

# Cennik mebli biurowych SILVER – meble do biur, gabinetów, sekretariatu itp

Podane ceny są cenami netto

Ilustrowany cennik w formacie .PDF na [www.edukacja-mikolow.pl](http://www.edukacja-mikolow.pl)

Wzornictwo oraz ceny podane w cennikach czy w katalogu mogą ulec zmianie i nie stanowią oferty w myśl k.c.

43-190 Mikołów, ul. Rybnicka 132,  
NIP: 635-10-05- 552



tel. 32 738 52 62 lub 32 738 54 94  
e-mail: [biuro@edukacja-mikolow.pl](mailto:biuro@edukacja-mikolow.pl)

Edukacja – pomoce dydaktyczne i wyposażenie szkół – Sp. z o.o.

## Zestaw mebli biurowych SILVER wygląd ogólny, biurka do biur i innych pomieszczeń biurowych, szafy i regały

Dostępne zestawy kolorów – na końcu cennika

**BUK BAWARIA+ szara platyna**

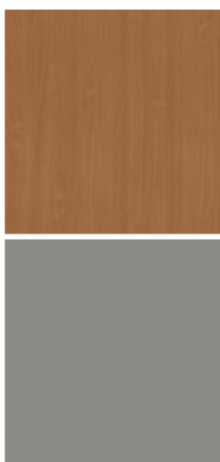

**BUK BAWARIA**



**GRUSZA POLNA+ szara platyna**



**GRUSZA POLNA**



**DĄB SONOMA + szara platyna**

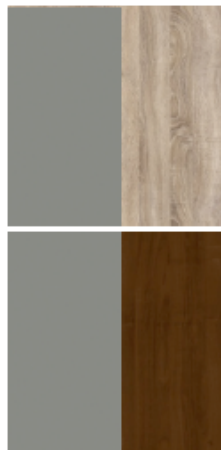

**ORZECH CAMARO + szara platyna**



biurka na podstawach płytowych lub na podstawach metalowych typ S lub typ M, dostawki i kontenerki do biurek na kółkach oraz kontenery recepcyjne, regały aktowe zamykane, otwarte i oszklone, regały narożne na dokumenty, nadstawki szaf i regałów, szafa na ubrania

Potwierdź dostępność / czas realizacji / aktualne ceny e-mailem, lub telefonicznie

Zobacz także -

linia **TULUZA**

link do cennika mebli gabinetowych **TULUZA**

<https://www.edukacja-mikolow.pl/ceny/meble-biurove-tuluza-cennik.pdf>

### Wykonanie mebli biurowych - wzornictwo **SILVER**:

- blaty biurek, kontenerów, dostawek, topy dolne i górne regałów wykonane z płyt o grubości 22 mm
- bolki biurek, korpusy regałów i kontenerów z płyt o grubości 18 mm
- tyły szaf i regałów z płyt HDF

Poniżej przedstawiamy elementy mebli biurowych gabinetowych typ **SILVER** wraz z cenami i wymiarami i szkicem

**Podano wymiary oraz ceny netto obowiązujące od 01.01.2025 – wzornictwo i podane ceny i mogą ulec zmianie.**

Podane ceny dotyczą wyposażenia standardowego bez kosztów montażu i dostawy. Sprawdź cenę i warunki realizacji telefonicznie lub e-mailem

### Biurka i stoliki na podstawach \ płyty meblowej

biurko **B80**

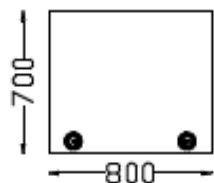

445 zł netto

biurko **B100**

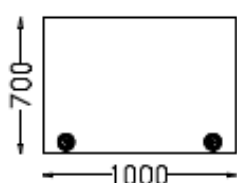

470 zł netto

biurko **B120**

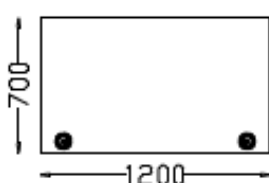
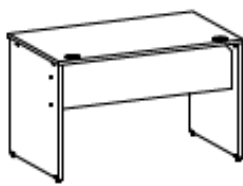

510 zł netto

biurko **B140**

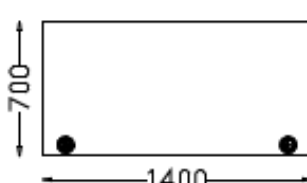

540 zł netto

biurko **B160**

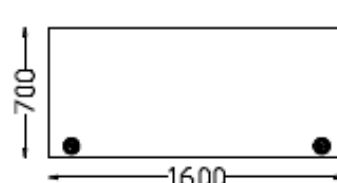
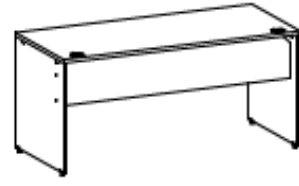

580 zł netto

biurko **BN140 L**

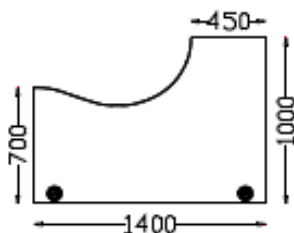
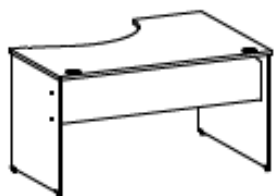

695 zł netto

biurko **BN140 P**

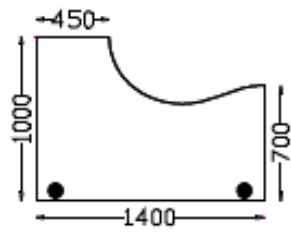
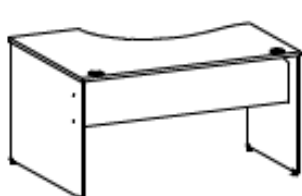

695 zł netto

biurko **BN160 L**

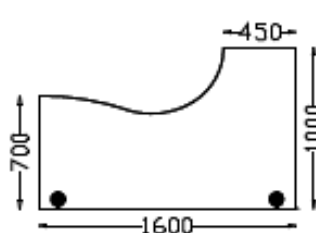
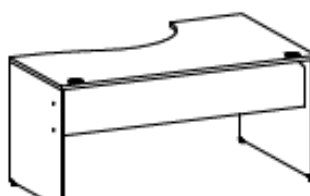

745 zł netto

biurko **BN160 P**

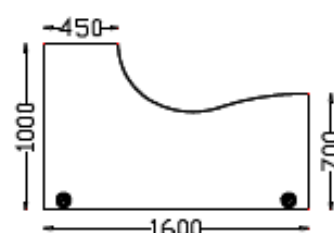
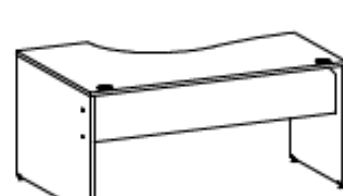

745 zł netto

## Biuorka i stoliki na podstawach metalowych typu S

biurko **B80 S**

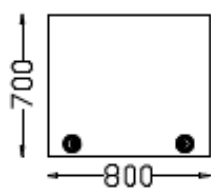

**605 zł netto**

biurko **B100 S**

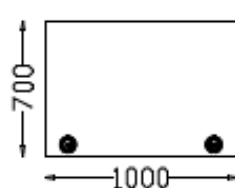

**639 zł netto**

biurko **B120 S**

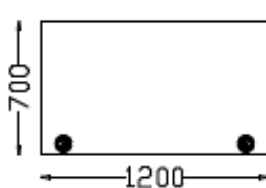
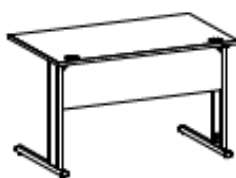

**666 zł netto**

biurko **B140 S**

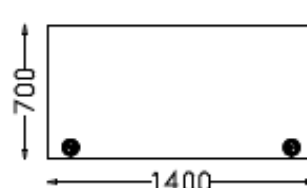
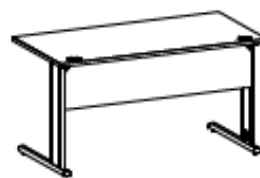

**676 zł netto**

biurko **B160 S**

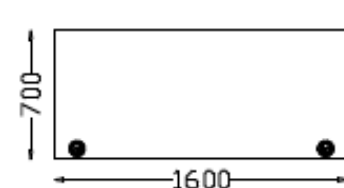

**734 zł netto**

biurko **BN140 L S**

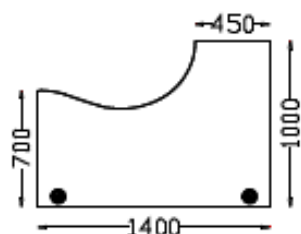
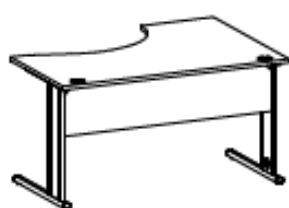

**841 zł netto**

biurko **BN140 P S**

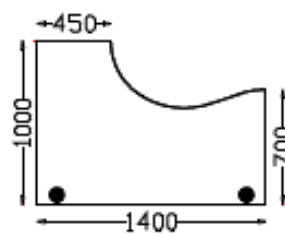
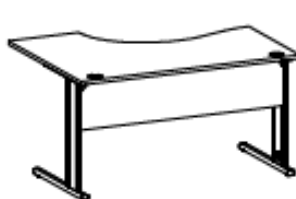

**841 zł netto**

biurko **BN160 L S**

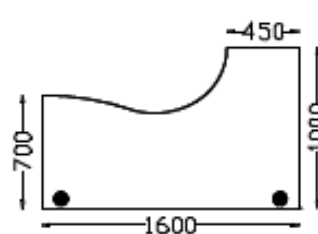
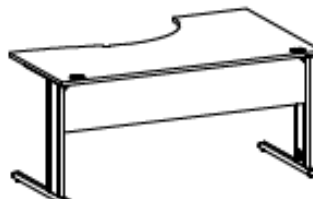

**896 zł netto**

biurko **BN160 P S**

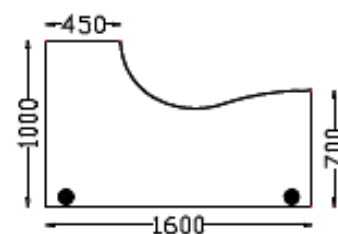
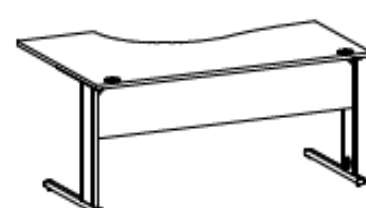

**896 zł netto**

\*szkic stelaża metalowego typu S do biurerek

B80S , B100S , B120S , B140S , B160S , BN140L S , BN140P S , BN160L S , BN160P S , ST190 S



**Podano wymiary oraz ceny netto obowiązujące od 01.01.2025 – wzornictwo i podane ceny i mogą ulec zmianie.**

**Podane ceny dotyczą wyposażenia standardowego bez kosztów montażu i dostawy. Sprawdź cenę i warunki realizacji telefonicznie lub e-mailem**

## Biurka i stoliki na podstawach metalowych typu G

biurko **B80 G**

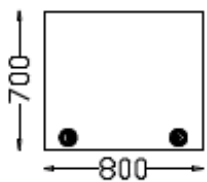

775 zł netto

biurko **B100 G**

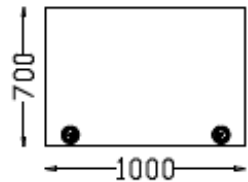

796 zł netto

biurko **B120 G**

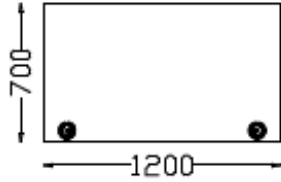

817 zł netto

biurko **B140 G**

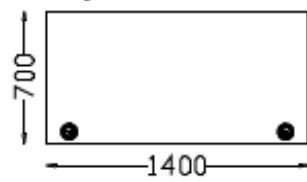
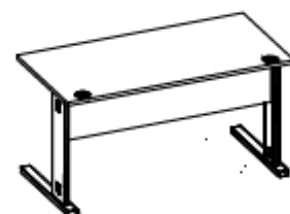

855 zł netto

biurko **B160 G**

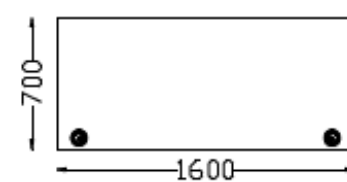
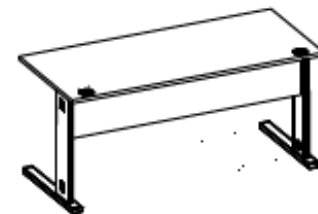

893 zł netto

biurko **BN140 L G**

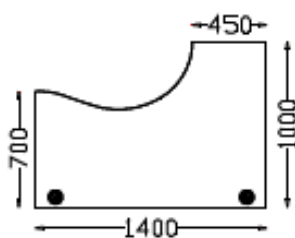
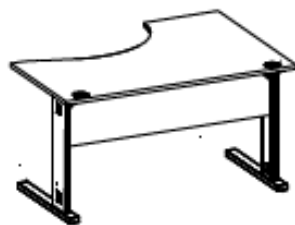

950 zł netto

biurko **BN140 P G**

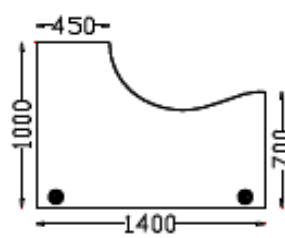

950 zł netto

biurko **BN160 L G**

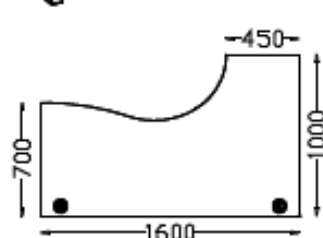
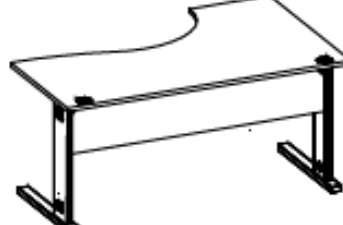

995 zł netto

biurko **BN160 G**

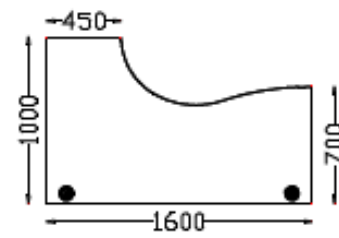
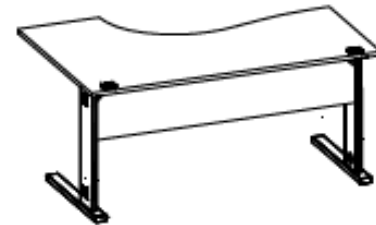

995 zł netto

\* szkielet stalowy typu **G** do biur

B80G , B100G , B120G , B140G , B160G , BN140L G , BN140P G , BN160L G , BN160P G , ST190 G

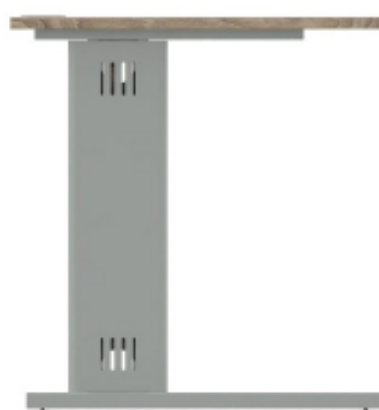

## Biurka i stoliki na podstawach metalowych typu FE

biurko **B80 FE**

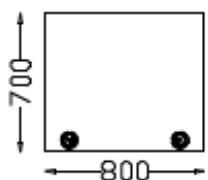

877 zł netto

biurko **B100 FE**

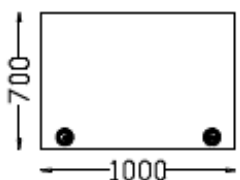

925 zł netto

biurko **B120 FE**

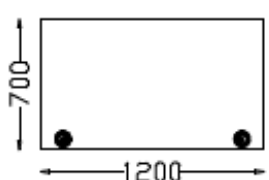

980 zł netto

biurko **B140 FE**

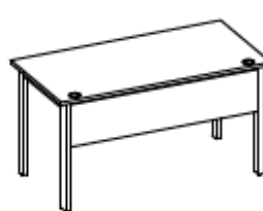

1.036 zł netto

biurko **B160 FE**

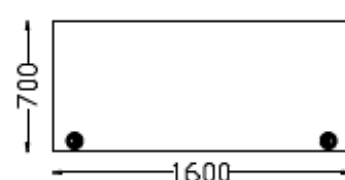
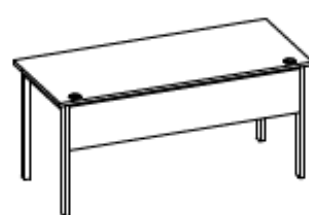

1.075 zł netto

biurko **BN140 L FE**

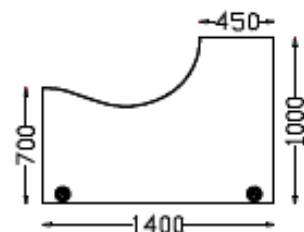
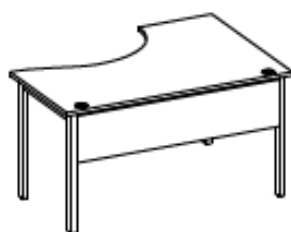

1.130 zł netto

biurko **BN140 P FE**

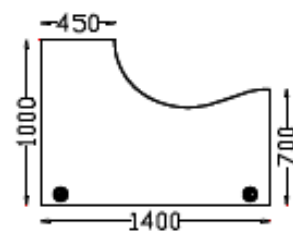

1.130 zł netto

biurko **BN160 L FE**

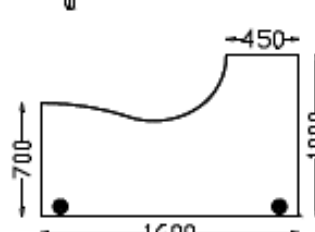

1.190 zł netto

biurko **BN160 FE**

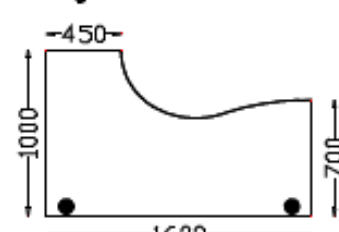
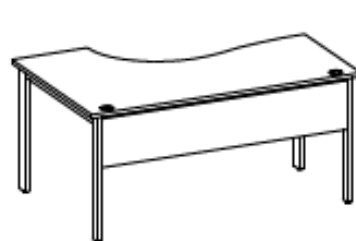

1.190 zł netto

\* szkic stelaża metalowego typu **FE** do biurzek

B80FE , B100FE , B120FE , B140FE , B160FE , BN140L FE , BN140P FE , BN160L FE , BN160P FE , ST190 FE



**Podano wymiary oraz ceny netto obowiązujące od 01.01.2025 – wzornictwo i podane ceny i mogą ulec zmianie.**

**Podane ceny dotyczą wyposażenia standardowego bez kosztów montażu i dostawy. Sprawdź cenę i warunki realizacji telefonicznie lub e-mailem**

## Stoły i stoliki

stół konferenc. **ST190**  
1900x900x740h

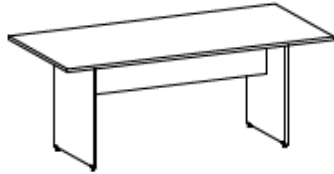

680 zł netto

stół konferenc. **ST190 S**  
1900x900x740h

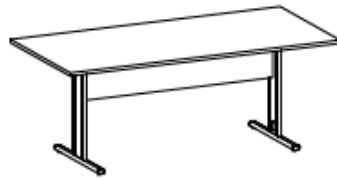

794 zł netto

stół konferenc. **ST190 G**  
1900x900x740h

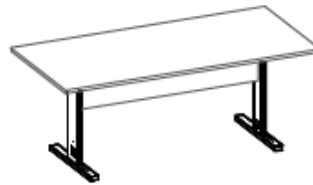

1.025 zł netto

stół konferenc. **ST190 FE**  
1900x900x740h

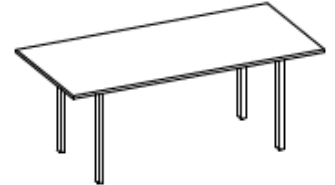

1.050 zł netto

stolik **ST80**  
800x800x740h



366 zł netto

stolik **ST80R**  
śr. 800x740h



373 zł netto

stolik **ST80Rm**  
śr. 800x740h



794 zł netto

stolik niski **SK**  
700x550x550h



275 zł netto

## Dostawki recepcyjne do biurka (na podstawach z płyty meblowej)

dostawka recepcyjna  
**DR-80**  
800x360x1100h

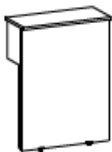

445 zł netto

dostawka recepcyjna  
**DR-100**  
1000x360x1100h

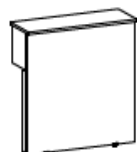

476 zł netto

dostawka recepcyjna  
**DR-120**  
1200x360x1100h



482 zł netto

dostawka recepcyjna  
**DR-140**  
1400x360x1100h



506 zł netto

dostawka recepcyjna  
**DR-160**  
1600x360x1100h

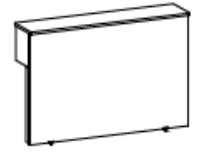

520 zł netto

### \* montaż dostawki DR do biurka

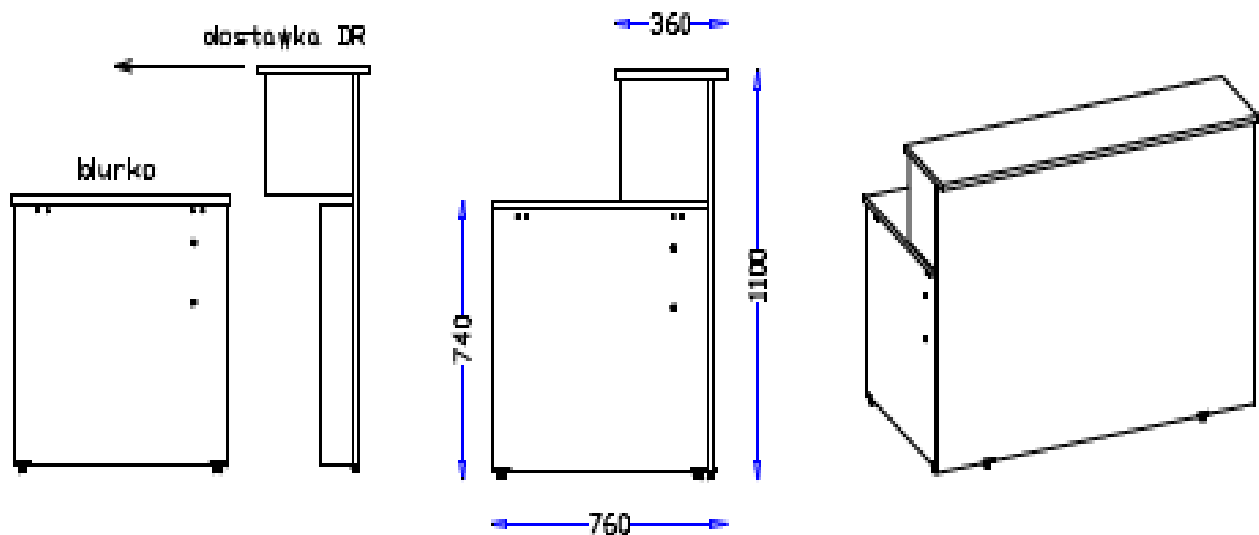

## Kontenery szufladowe i szafki do biur

kontener mobilny

**K51**

420x550x600h



589 zł netto

kontener mobilny

(z piórnikiem) **K52**

420x550x600h



770 zł netto

kontener stacjonarny

**K55**

420x700x740h



820 zł netto

szafka stacjonarna

**K56**

700x450x740h



514 zł netto

szafka stacjonarna

(drzwi przesuwne) **K56A**

700x450x740h



610 zł netto

kontener stacjonarny

**K53**

420x450x740h



720 zł netto

kontener stacjonarny

**K53A L K53A P**

420x450x740h

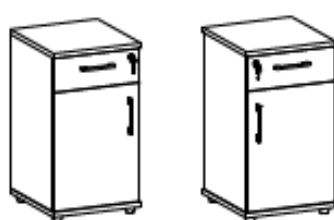

514 zł netto

kontener stacjonarny

**K53B L K53B P**

420x450x740h

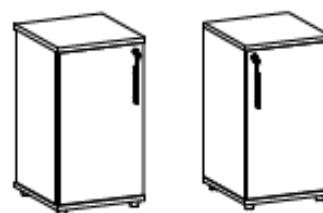

497 zł netto

## Elementy dodatkowe do biur

kaseta na klawiaturę **K-KL**

560x340x80h



99 zł netto

podstawa jezdna na **PC**

275x505x105h



86zł netto

łącznik biur **P-90**

700x700 (¼ koła)



176 zł netto

łącznik biur **P-180**

1400x700 (½ koła)



267 zł netto

noga metalowa śr. 50mm **N**

śr.50 x718h



90 zł netto

## Regały i szafy

Uwaga : montaż zamka patentowego do szaf i regalów

25 zł netto / 1szt

regal **R80-2**

800x400x796h



330 zł netto

regal **R80-2A**

800x400x796h



530 zł netto

regal **R80-3**

800x400x1147h

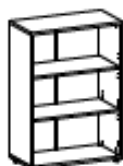

410 zł netto

regal **R80-3A**

800x400x1147h

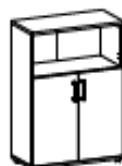

625 zł netto

regal **R80-3B**

800x400x1147h



640 zł netto

regal **R80-3C**

800x400x1147h



740 zł netto

regal nar. **RW80-3**  
800x800x1147h

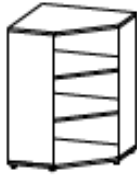

**916 zł netto**

regal nar. **RW80-3A**  
800x800x1147h

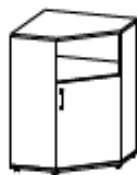

**990 zł netto**

regal nar. **RW80-3B**  
800x800x1147h



**1.070 zł netto**

regal **RZ40-3**  
400x400x1147



**445 zł netto**

regal **R80-5**  
800x400x1867h

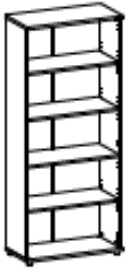

**550 zł netto**

regal **R80-5A**  
800x400x1867h

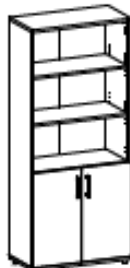

**760 zł netto**

regal **R80-5B**  
800x400x1867h



**1.020 zł netto**

regal **R80-5C**  
800x400x1867h



**1.080 zł netto**

regal **R80-5D**  
800x400x1867h

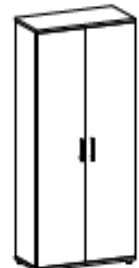

**860 zł netto**

sz. ubr. **S60-5**  
600x400x1867h



**660 zł netto**

regal **R40-5**  
400x400x1867h



**440 zł netto**

regal **R40-5A**  
400x400x1867h



**550 zł netto**

regal **R40-5B**  
400x400x1867h



**660 zł netto**

regal nar. **RW80-5**  
800x800x1867

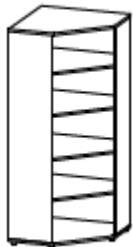

**1.150 zł netto**

regal nar. **RW80-5A**  
800x800x1867



**1.250 zł netto**

regal nar. **RW80-5B**  
800x800x1867

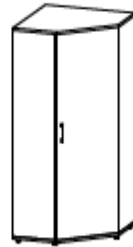

**1.370 zł netto**

regal **RZ40-5**  
400x400x1867

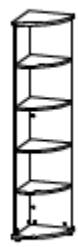

**540 zł netto**

## Nadstawki do regałów i szaf

nadstawka **N80-2**  
800x400x744h



**300 zł netto**

nadstawka **N80-2A**  
800x400x744h



**480 zł netto**

nadstawka **N40-2**  
400x400x744h



**240 zł netto**



nadstawka N40-2A  
400x400x744h



320 zł netto

nadstawka NW80-2  
800x800x744h

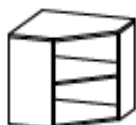

695 zł netto

nadstawka NW80-2A  
800x800x744h



777 zł netto

nadstawka NZ40-2  
400x400x744h









280 zł netto

## Dostępność vs kolorystyka mebli z zestawu SILVER

meble dostępne od 0 – 5 dni roboczych

nazwa dekoru	próbka pogładowa	
dąb Sonoma + szara platyna		
orzech Camaro + szara platyna		
buk bawaria + szara platyna		
grusza polna + szara platyna		
buk bawaria ( całość )		
grusza polna ( całość )		

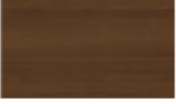
meble dostępne od 10 – 20 dni roboczych

nazwa dekoru	próbka pogładowa	
klon Vancouver + szara platyna		
dąb Country + szara platyna		
Dąb Sonoma ( całość )		
orzech Camaro ( całość )		
dąb Country ( całość )		

meble w innych kolorach do uzgodnienia

dekory **SwissKrono , Kronospan ,  
Egger , Pfleiderer**